

Liquid Level Controller

- Fully Automatic operation enabling both draining and filling simultaneously with a single device
- Adjustable sensitivity level from 1k to 200k Ohm
- Includes provision for Manual start
- Protects submersible pumps against dry running and prevents overfilling
- Enables maximum utilization of incoming liquid (eg. water) supply
- Specially designed corrosion and shock resistant sensors to ensure trouble free operation.



Cat. No.	4411AD1	4421AD1	4431AD1
Parameters			
Supply Voltage (φ)	110VAC, +/-20%	240VAC, +/-20%	400VAC, +/-20%
Frequency	47Hz - 63Hz		
Power Consumption (Max.)	3VA		
Device Characteristics			
Conductive Sensor Probes	Stainless Steel SS304, 3 or 6Nos		
Sensor Length	10 cm		
Control Action Modes	Only Draining, Only Filling, Draining & Filling Simultaneous (One Tank or Two tanks)		
Sensitivity	1K to 200 K Ohm (Potentiometer adjustable)		
Sensor Voltage & Current	12 Vp-p, 100 Hz, < 1 mA		
Sensor cable	Cable gauge (Min):0.5 sq mm Tin coated, Cable dia(Min):1.5mm Max Cable Length-1000m (For set value < 50%) Max Cable Length-300m (For set value 100%) Max capacitances of wire- 80 nF / km		
Manual Start Switch	If Lower tank water level is greater than Low level & upper tank water level is below High level then by pressing a switch Relay can be switched ON manually.		
Output Control Mode	Relay ON/OFF		
Contact Ratings	1 C/O,8A@250VAC,Resistive,Terminal 15-Pole, Terminal 16-NC,Terminal 18-NO		
Utilization Category	AC-15: Rated Voltage (Ue):120/240V, Rated Current(Ie): 3.0/1.5A DC-13: Rated Voltage (Ue):24/125/250V, Rated Current(Ie): 2.0/0.22/0.1A		
Electrical Life	1 x 10 ⁵ Operations		
Mechanical Life	1 x 10 ⁷ Operations		
LED Indication	GREEN LED: Power ON, RED LED : Relay Output ON		
Operating Temperature	-10°C to +60°C		
Storage Temperature	-10°C to +70°C		
Relative Humidity	5 to 95 % RH (non condensing)		
Mounting	Base/DIN Rail		
Dimension (W x H x D) (in mm)	36 X 90 X 65		
Weight (unpacked)	235 g (Controller), 45 g (Sensor)		
Certification			
EMI/EMC			
Harmonic Current Emission	IEC 61000-3-2	Ed. 4.0 (2014-05) Class A	
ESD	IEC 61000-4-2	Ed. 2.0 (2008-12) Level II	
Radiated Susceptibility	IEC 61000-4-3	Ed. 3.2 (2010-04) Level III	
Electrical Fast Transient Surge	IEC 61000-4-4	Ed. 3.0 (2012-04) Level IV	
Conducted Susceptibility	IEC 61000-4-5	Ed. 3.0 (2014-05) Level IV	
Voltage Dips & Interruptions (AC)	IEC 61000-4-6	Ed. 4.0 (2013-10) Level III	
Conducted Emission	IEC 61000-4-11	Ed. 2.0 (2004-03) All seven Levels	
Radiated Emission	CISPR 14-1	Ed. 5.2 (2011-11) Class B	
	CISPR 14-1	Ed. 5.2 (2011-11) Class B	
ENVIRONMENTAL			
Cold Heat	EC 60068-2-1	Ed. 6.0 (2007-03)	
Dry Heat	IEC 60068-2-2	Ed. 5.0 (2007-07)	
Vibration	IEC 60068-2-6	Ed. 7.0 (2007-12) 5g	
Repetitive Shock	IEC 60068-2-27	Ed. 4.0 (2008-02) 40g, 6ms	
Non-Repetitive Shock	IEC 60068-2-27	Ed. 4.0 (2008-02) 30g, 15ms	

ORDERING INFORMATION

Cat-No	Description
4411AD1	110VAC, 1 C/O,1K to 200K Sensitivity, Draining & Filling
4421AD1	240VAC, 1 C/O,1K to 200K Sensitivity, Draining & Filling
4431AD1	400VAC, 1 C/O,1K to 200K Sensitivity, Draining & Filling
44S0003	Accessories, Set Of 3 Stainless Steel Sensors
44S0006	Accessories, Set Of 6 Stainless Steel Sensors

Liquid Level Controller



OPERATING FUNCTION DIAGRAM

Simultaneous filling and draining with 6 Sensors

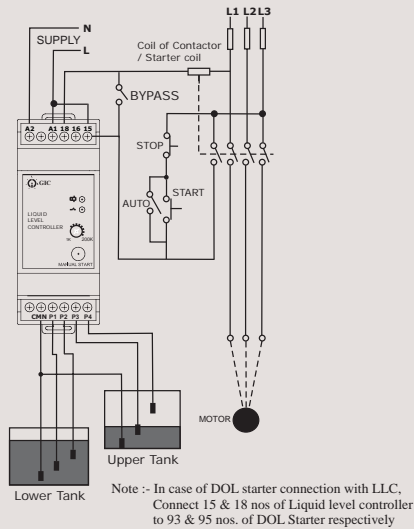

The system starts up whenever the upper tank requires liquid and the lower tank has sufficient level to supply it, and it stops when the liquid reaches its maximum level in the upper tank or if the Lower tank reaches its minimum level. If all Sensors are non conducting then Relay is "OFF". If Liquid level reaches "P1" Sensor then relay will be OFF (maintains previous state). When the level reaches "P2" Sensor then relay will be switched ON (As the liquid level has reached maximum level of Lower tank). Now Filling of Upper tank will start. When liquid level reaches "P3" Sensor, relay will be ON (maintains previous state). Now when liquid level reaches "P4" Sensor relay will be switched "OFF" (As Liquid level has reached maximum level in the Upper tank). Now if Liquid level of upper tank is decreasing and it goes below "P4" Sensor, then the relay will be "OFF" (Maintains previous state), But when it falls below "P3" level, then relay will be switched "ON" until the liquid level is more than "P1" Sensor (i.e. until there is enough liquid in the upper tank).

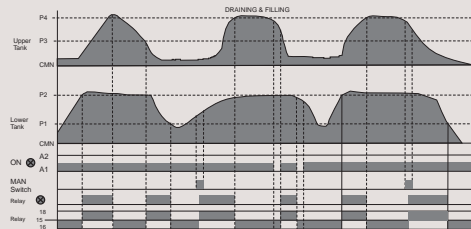

P1	P2	P3	P4	Relay & RED LED Indication
OUT	OUT	OUT	OUT	OFF
IN	OUT	OUT	OUT	OFF
IN	IN	OUT	OUT	ON
IN	IN	IN	OUT	ON
IN	IN	IN	IN	OFF
IN	IN	IN	OUT	OFF
IN	IN	OUT	OUT	ON
IN	OUT	OUT	OUT	ON
OUT	OUT	OUT	OUT	OFF

Filling Control (Single Tank Monitoring with 3 Sensors)

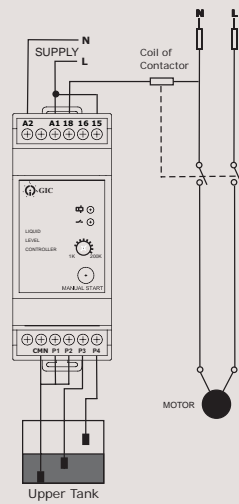

When the level in the tank drops below the low level Sensor, the relay energises. The relay then remains energized until the level reaches the high level Sensor. As soon as the high level Sensor becomes submerged, the relay de-energizes and remains OFF until the level has dropped sufficiently below the low level Sensor. When "P3" & "P4" are non-conducting i.e. tank is empty, Relay is "ON". Whenever water level reaches "P3" Sensor, then again the relay will be ON (Maintains previous state of relay). But when water level touches the "P4" Sensor, then relay will be switched "OFF" (As Liquid reaches the maximum level). Again when water level decreases below "P4" level, then the relay will be switched "OFF" (Maintains previous state of relay). When water level reaches below "P3", then the relay will be switched "ON" (As the Liquid reaches minimum level)

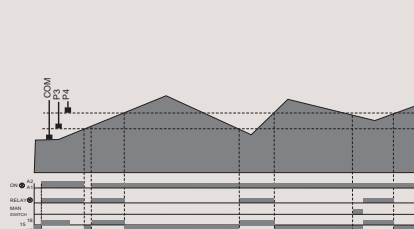

P3	P4	Relay & RED LED Indication
OUT	OUT	ON
IN	OUT	ON
IN	IN	OFF
IN	OUT	OFF
OUT	OUT	ON

Filling Control (Single level Monitoring with two Sensors)

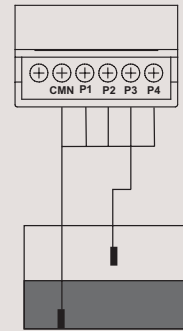

The output relay switches "ON" which starts up the relay when the Minimum level Sensor "P3" is no longer in contact with the liquid and switches "OFF" when the liquid reaches "P3". **This operation is not recommended for pump controlling.**

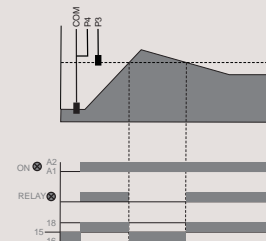

P3	Relay & RED LED Indication
OUT	ON
IN	OFF



OPERATING FUNCTION DIAGRAM

Draining Control (Single Tank Monitoring with 3 Sensors)

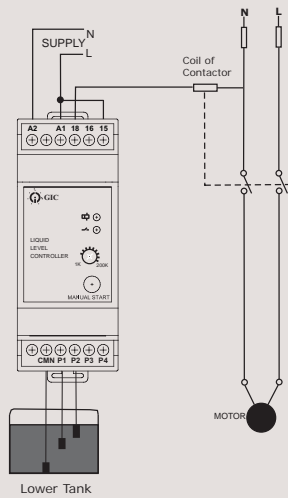

When the level in the tank rises sufficiently to submerge the high level Sensor, the relay energizes. The relay then remains energized until the level has dropped below the low level Sensor. As the liquid drops below the low level Sensor, the relay de-energizes and remains off until the level has risen sufficiently to submerge the high level Sensor. When "P1" & "P2" are non-conducting i.e. when the tank is empty, relay is "OFF". Whenever water level reaches "P1" Sensor, then again the relay will be "OFF" (maintains previous state of relay). But when water level touches the "P2" Sensor, then relay will be switched "ON" (as the Liquid reaches maximum level). Again, when water level decreases below "P2" level, then the relay will remain switched "ON" (maintains previous state of relay). When water level reaches below "P1", then relay will be switched "OFF" (as the liquid reaches minimum level).

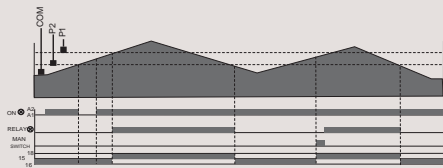

P1	P2	Relay & RED LED Indication
OUT	OUT	OFF
IN	OUT	OFF
IN	IN	ON
IN	OUT	ON
OUT	OUT	OFF

Draining Control (Single level Monitoring with two Sensors)

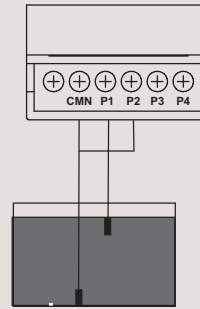

The output relay switches ON, when liquid level goes above a maximum level, fixed by the Sensor "P1", when the level drops below a "P1" Sensor, relay switches "OFF". **This operation is not recommended for pump controlling.**

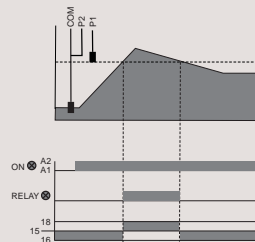

P1	Relay & RED LED Indication
OUT	OFF
IN	ON

Liquid Level Controller



SENSOR DIAGRAM

A single pole electrode used for level control in wells or storage tanks. It comprises of stainless steel Sensor with plastic holder and cable gland. A sealed ring and cable gland prevents liquid from entering the cable terminal connector and causing its oxidation.

Cable connection: Screw

The external cable diameter must be 1.5 mm to warrant perfect sealing.

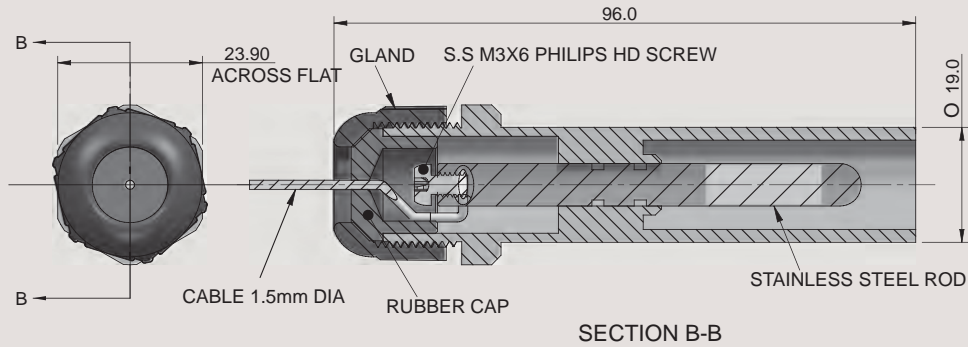

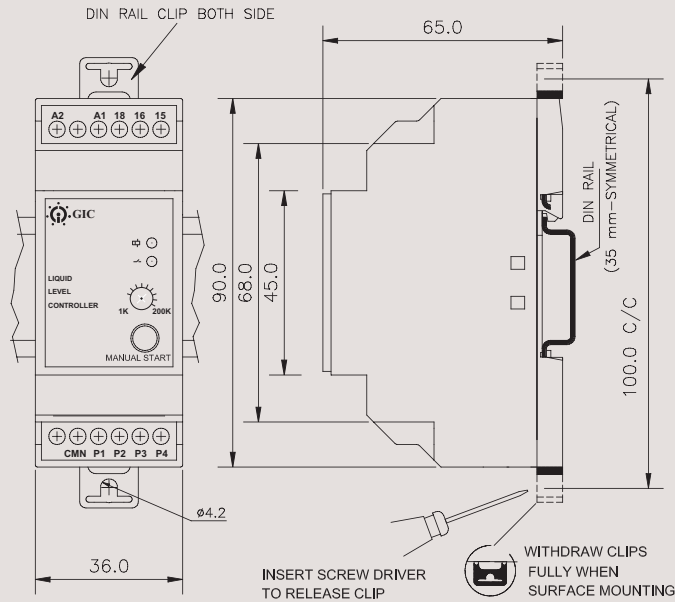

MOUNTING DIMENSIONS (mm)

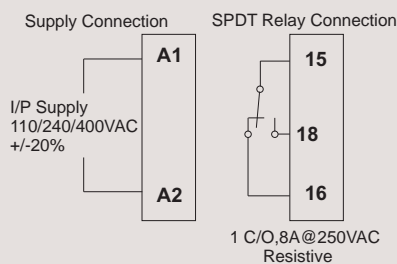

CONNECTION DIAGRAM

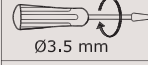

TERMINAL TORQUE & CAPACITY

 Ø3.5 mm	0.54 N.m (5 Lb.in) Terminal screw - M2.6
	1 x 0.2...3.3 mm ² Solid Wire
AWG	1 x 24 to 12